



DONGHUI Motor

DBL38250

OUTPUT: APPROX 10W~45W

OUTER ROTOR

WEIGHT : 120g (APPROX)



● Typical Application 典型应用

- 个人护理(Personal Care)
- 家用电器(Home Application)
- 电动工具(Industry Apparatus)
- 筋膜枪(Massage Gun)
- 医疗器械(Medical Apparatus)

● Connector Interface 连接端口

NO.	PIN ARRANGEMENT
1	VCC
2	FG
3	CW/CCW
4	GND
5	PWM

◆ External Dimensions 外形图

DIRECTION OF ROTATION

(CCW) ← (CW)

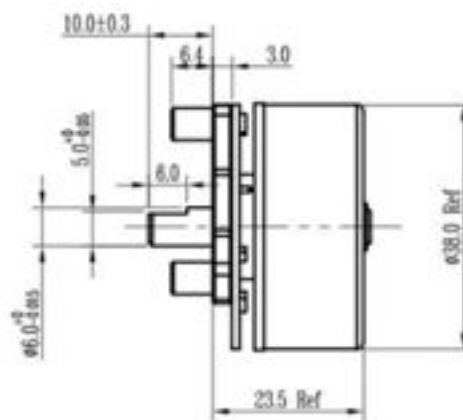
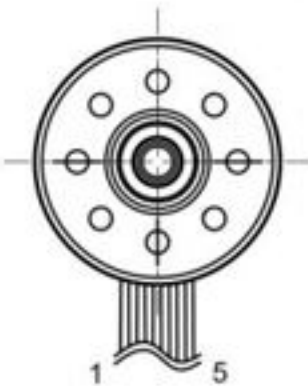

UNIT: MILLIMETERS

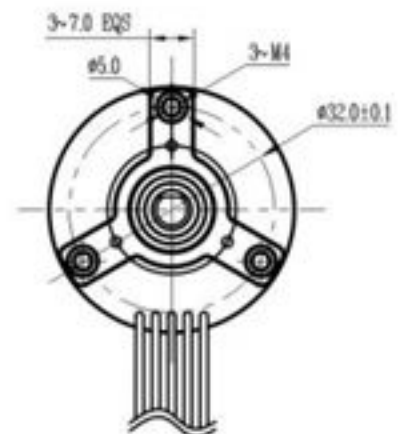

◆ Major Characteristic Parameters 主要特性参数

MODEL	VOLTAGE		NO LOAD		AT MAXIMUM EFFICIENCY				STALL	
	OPERATING RANGE	RATED	SPEED	CURRENT	SPEED	CURRENT	TORQUE	OUTPUT	TORQUE	CURRENT
			r/min	A	r/min	A	g.cm	W	g.cm	A
DBL38250-V1	8V~15V	12 V	3810	0.23	3230	1.4	397	26	2700	7.6
DBL38250-V2	8V~20V	16.8 V	3820	0.17	3300	1.08	438	32	3400	12
DBL38250-V3	8V~26V	24 V	3850	0.39	3385	0.9	490	40	4200	6.5

◆ Performance Curves 性能曲线

DBL38250-V1 12V

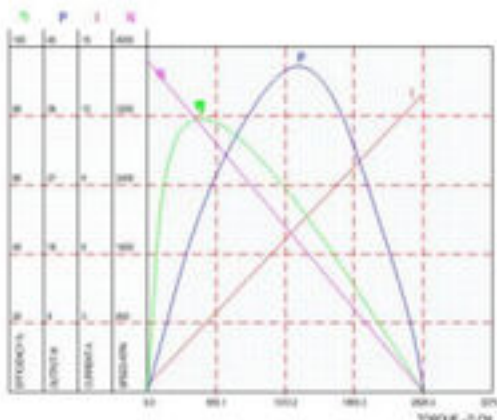

DBL38250-V3 24V

